

1

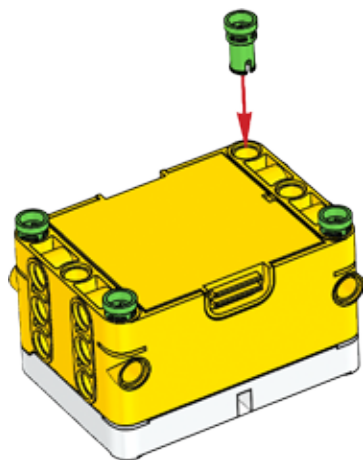

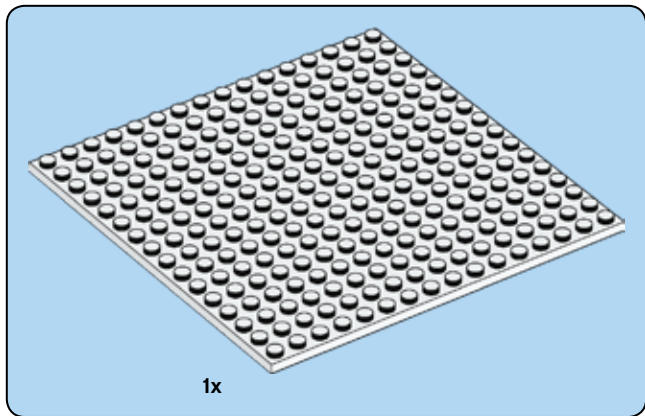

2

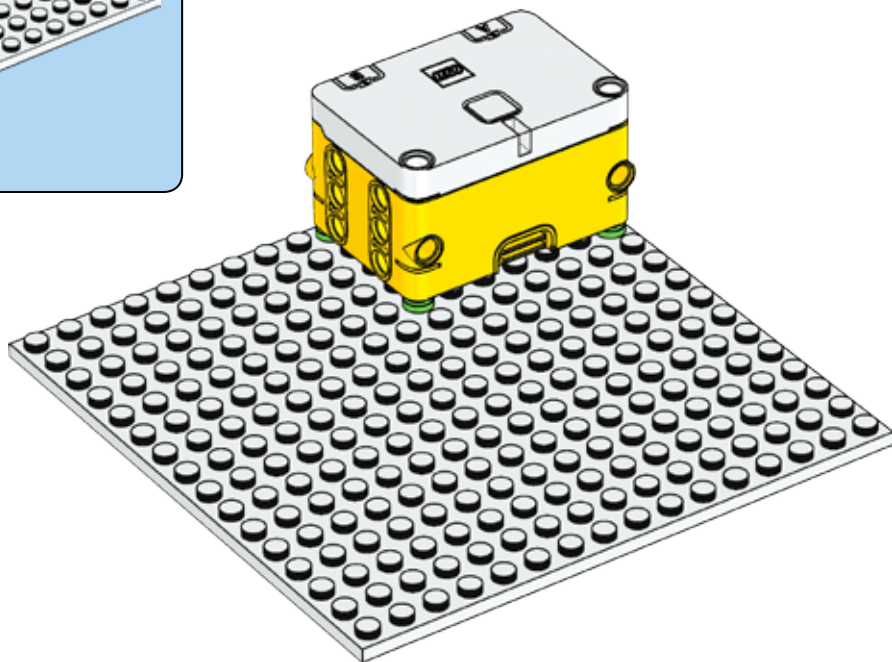

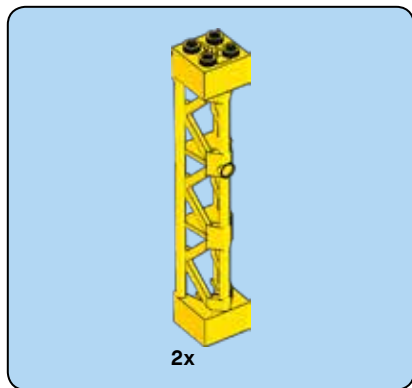

3

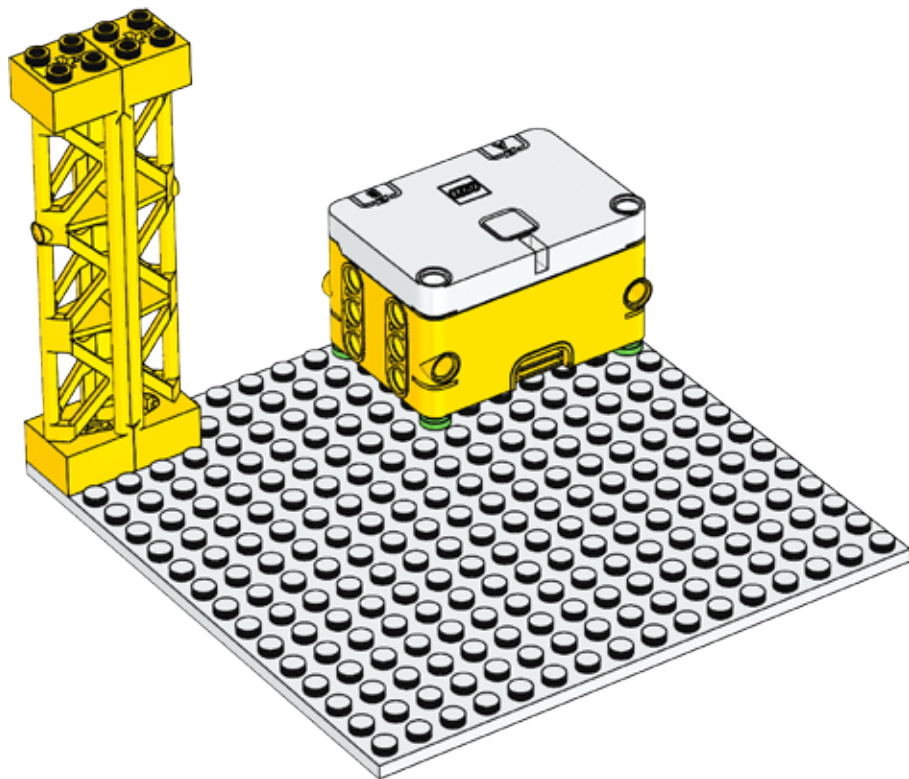

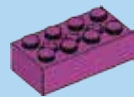

1x

4

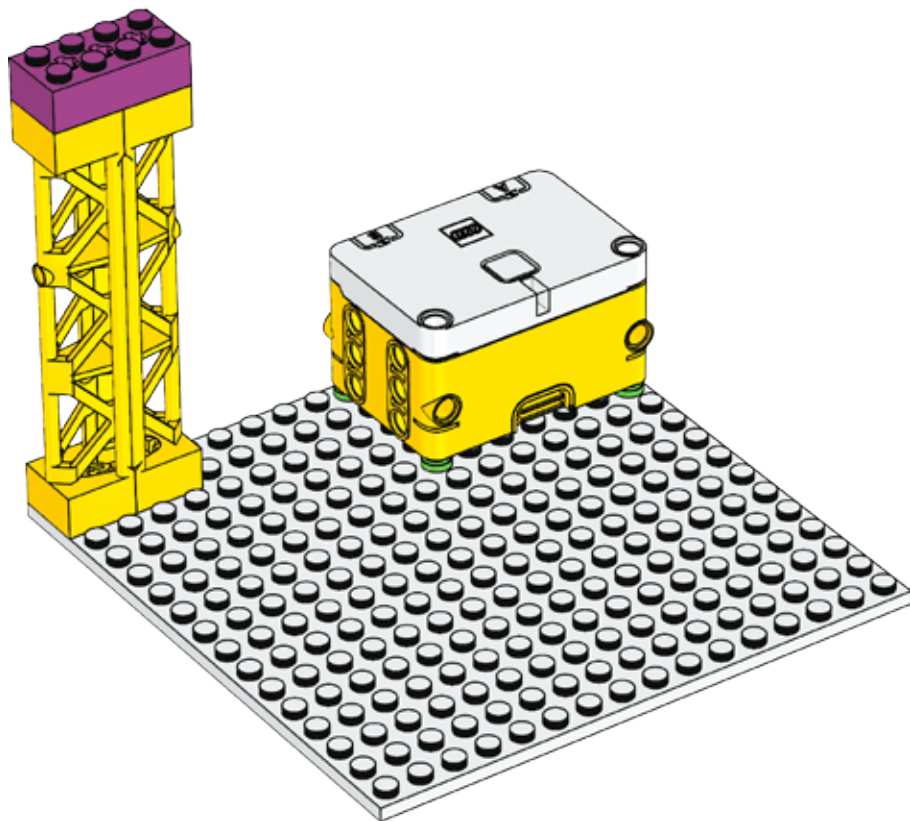



2x

5

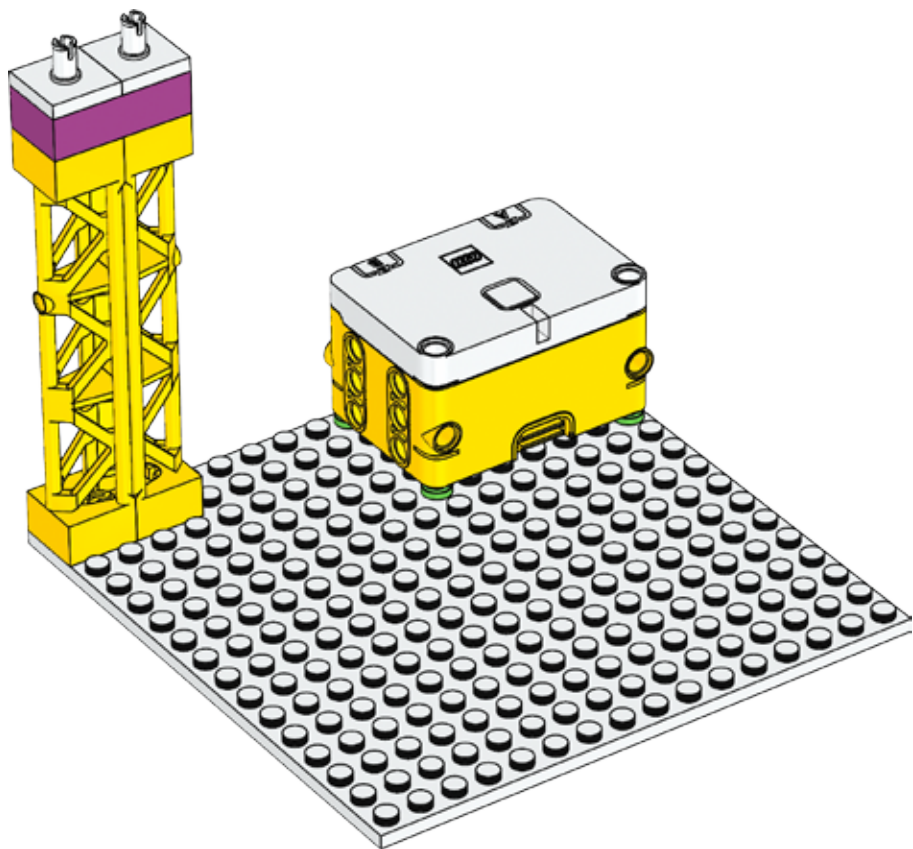



2x

6

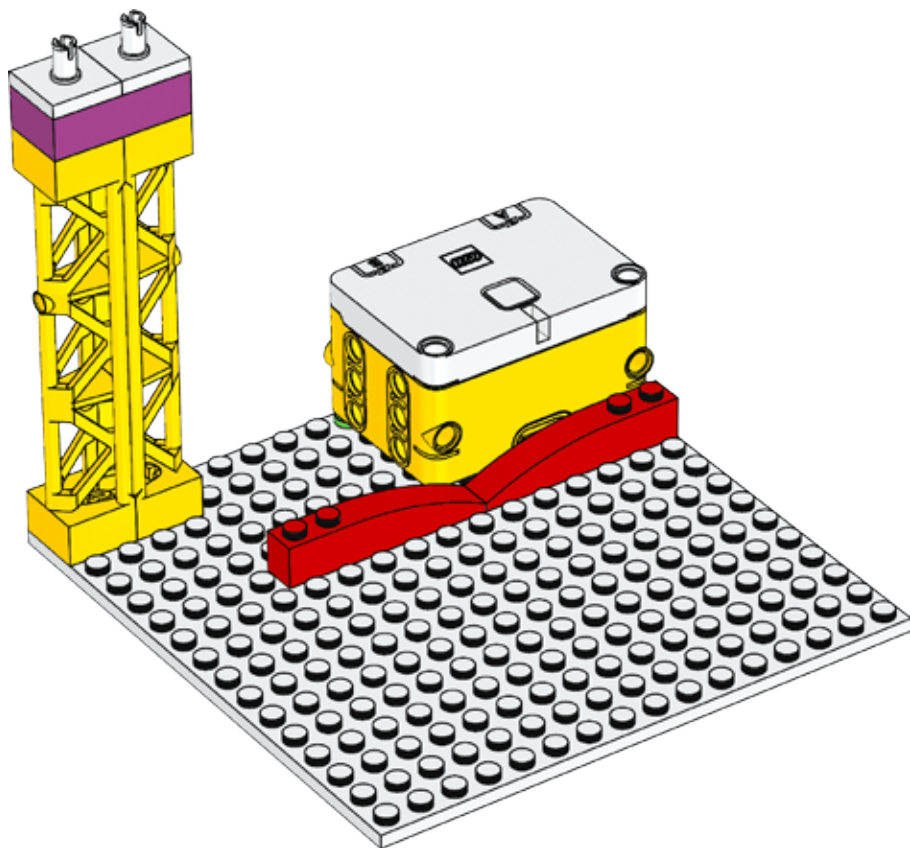

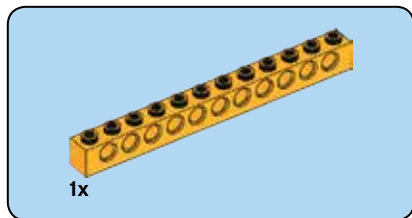

7

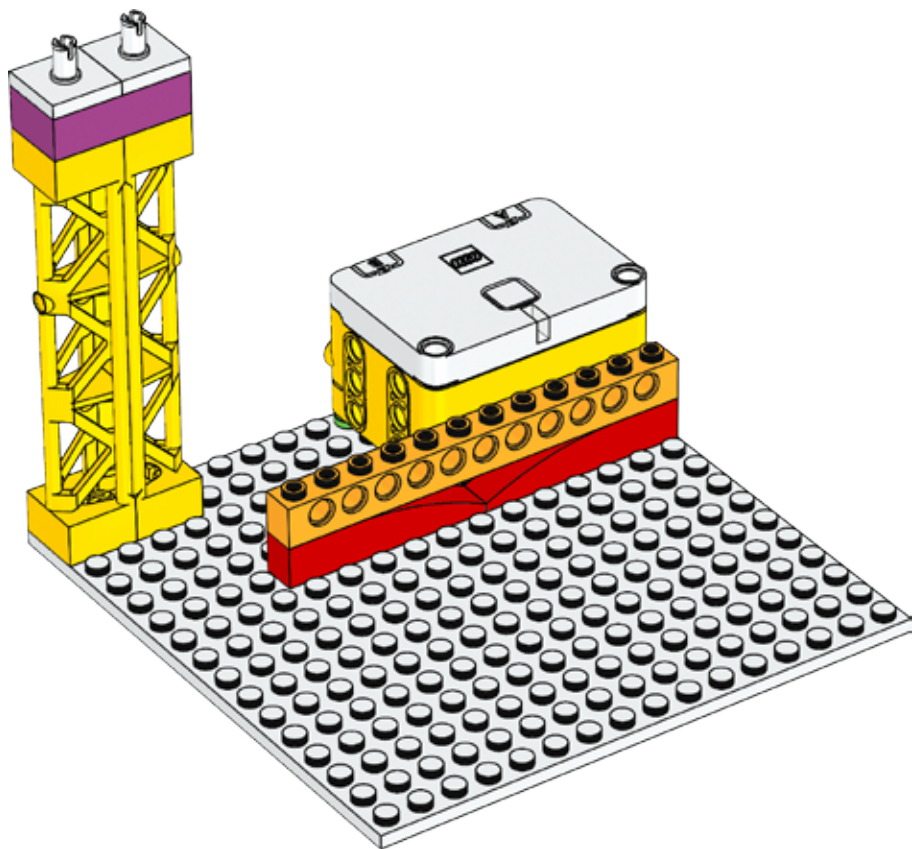





2x

8

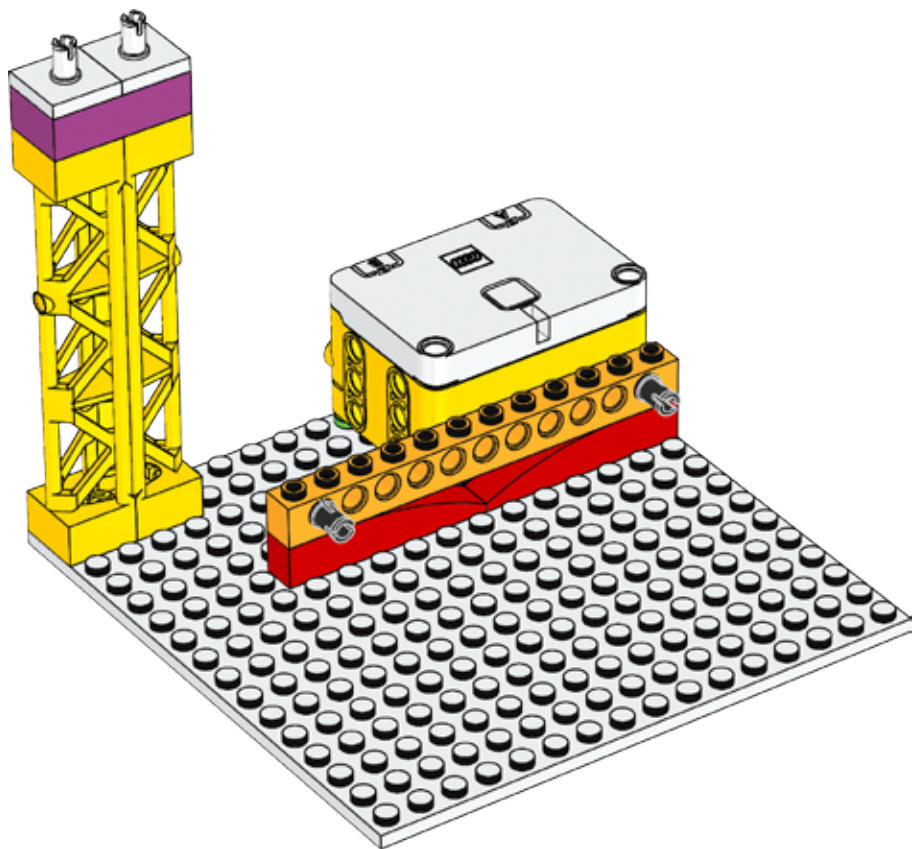





2x

9

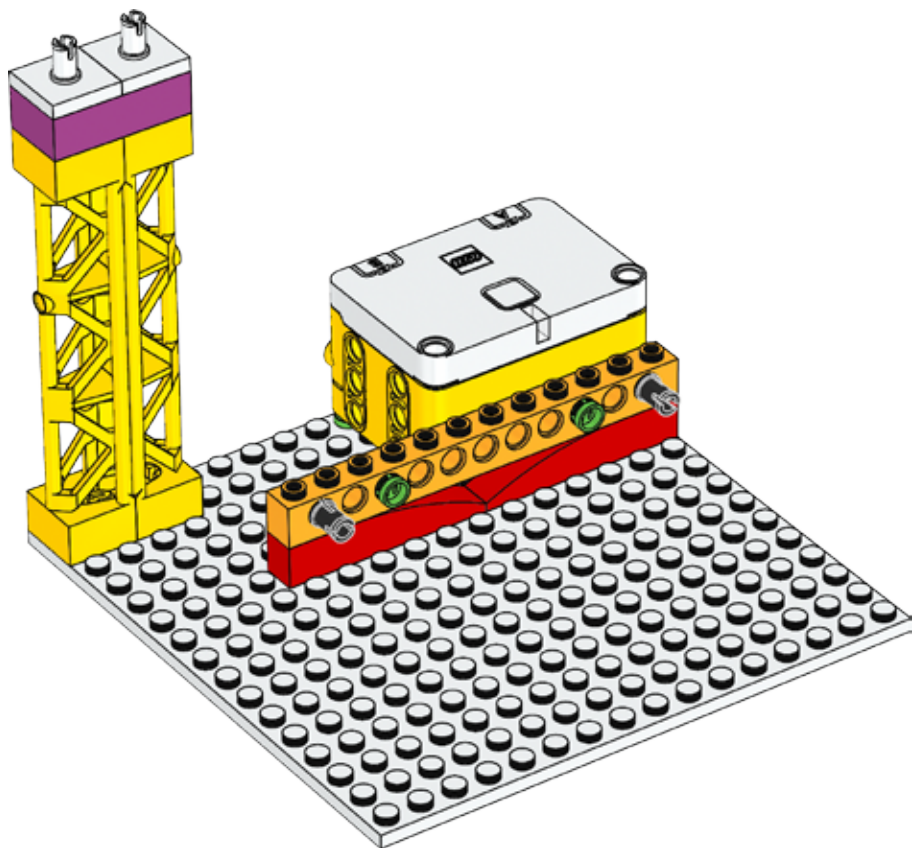

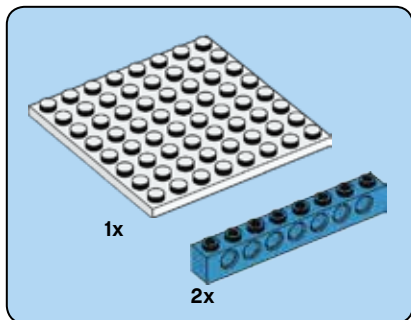

10

1

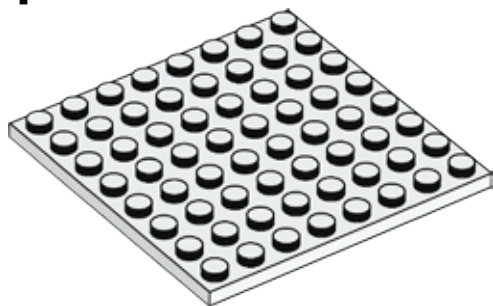

2

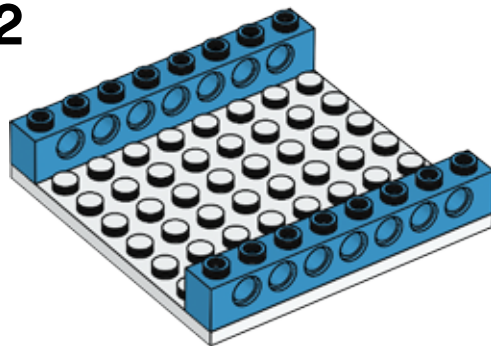

11

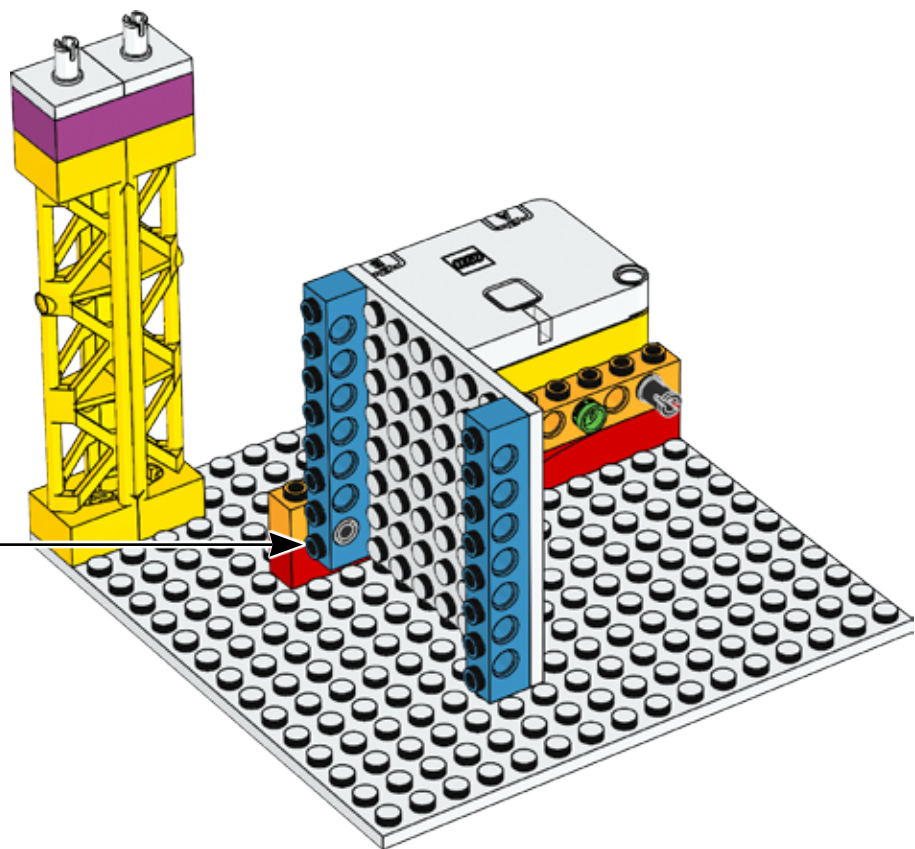

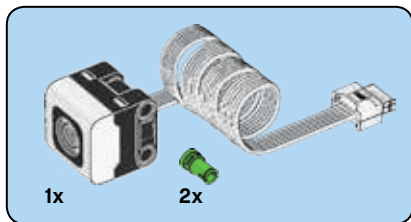

12

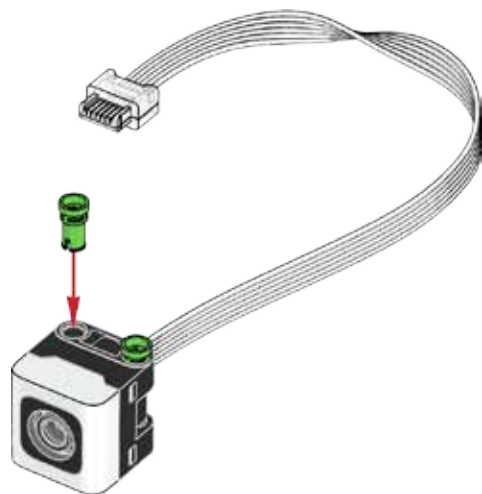

13

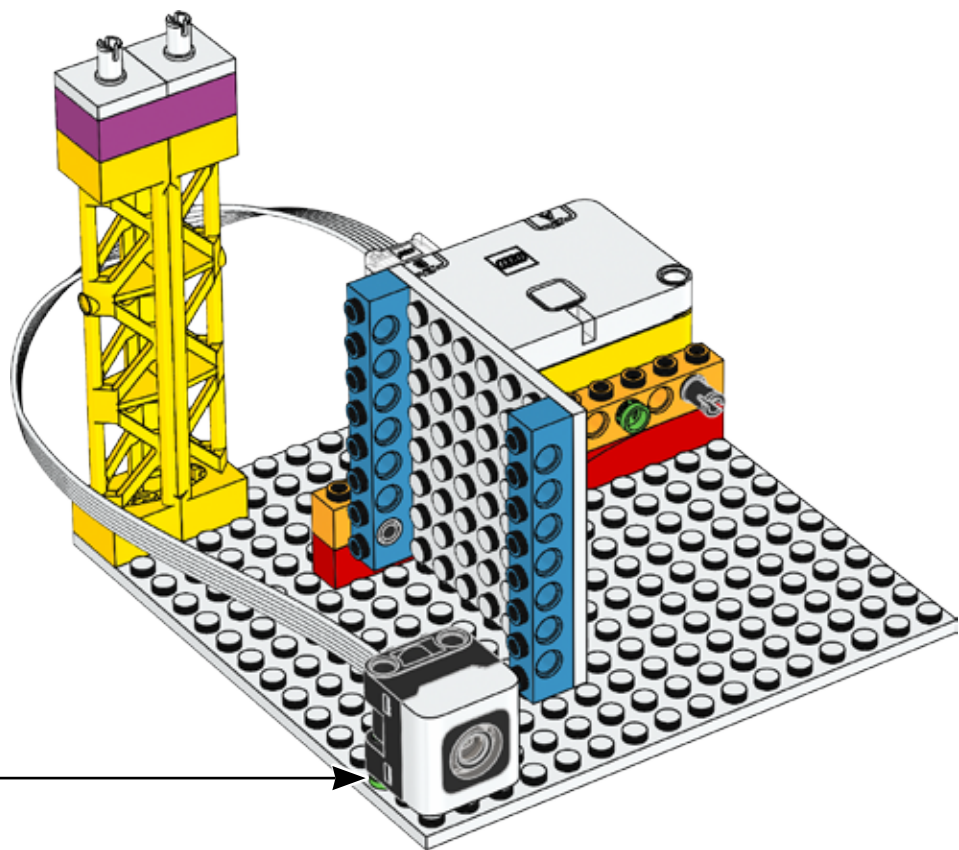

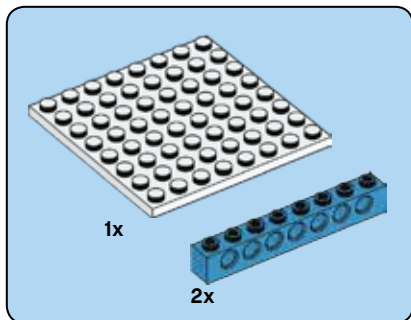

14

1

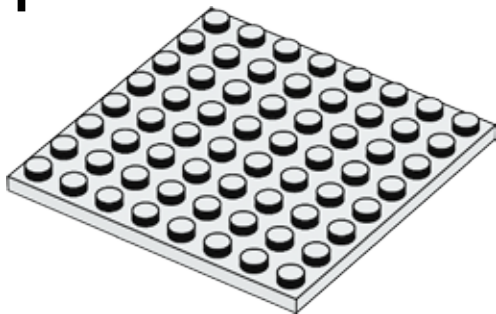

2

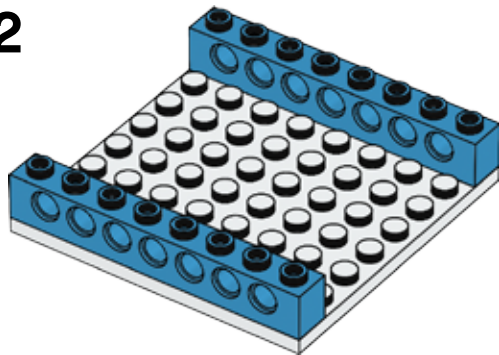

15

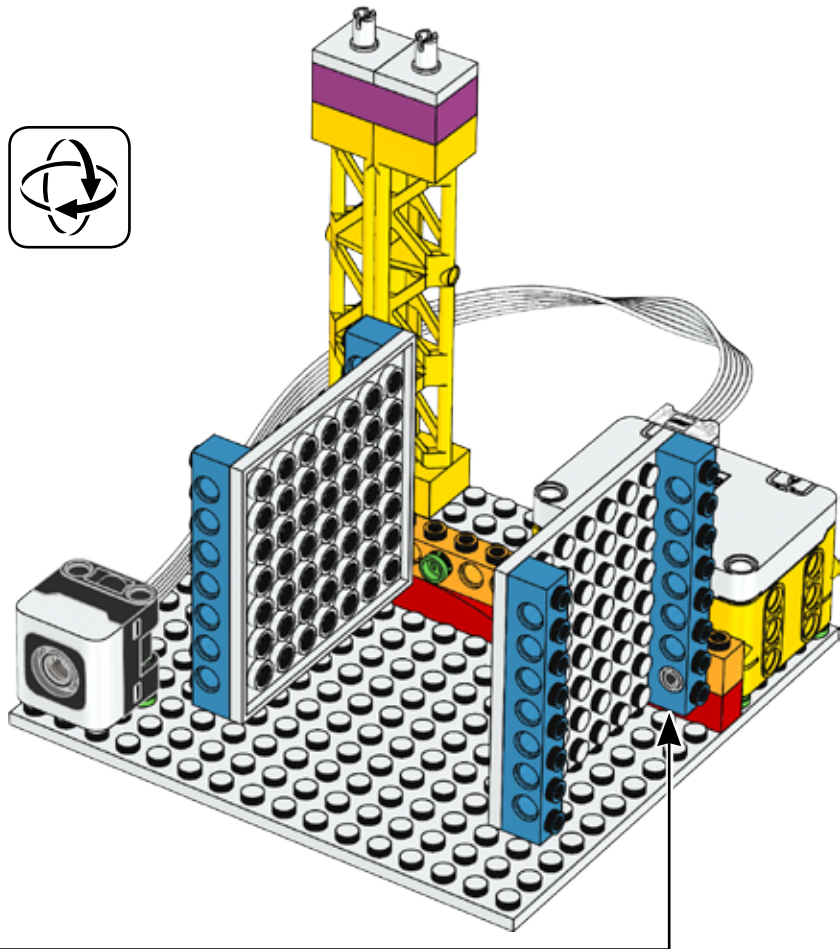





2x

16

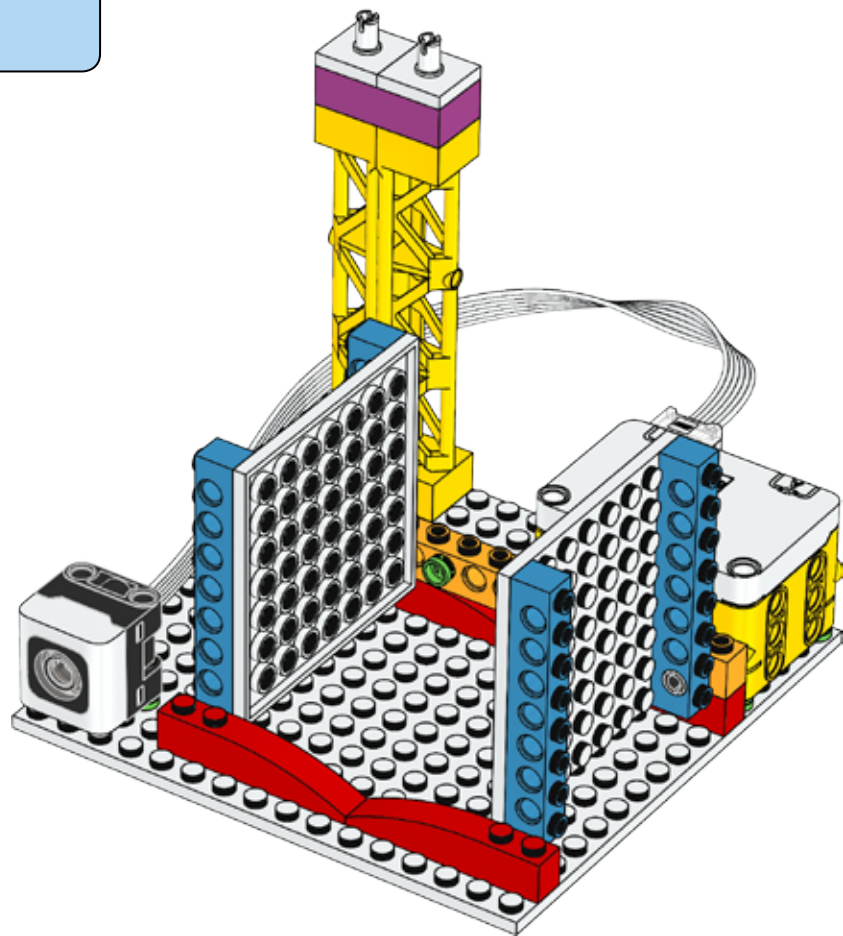



2x

17

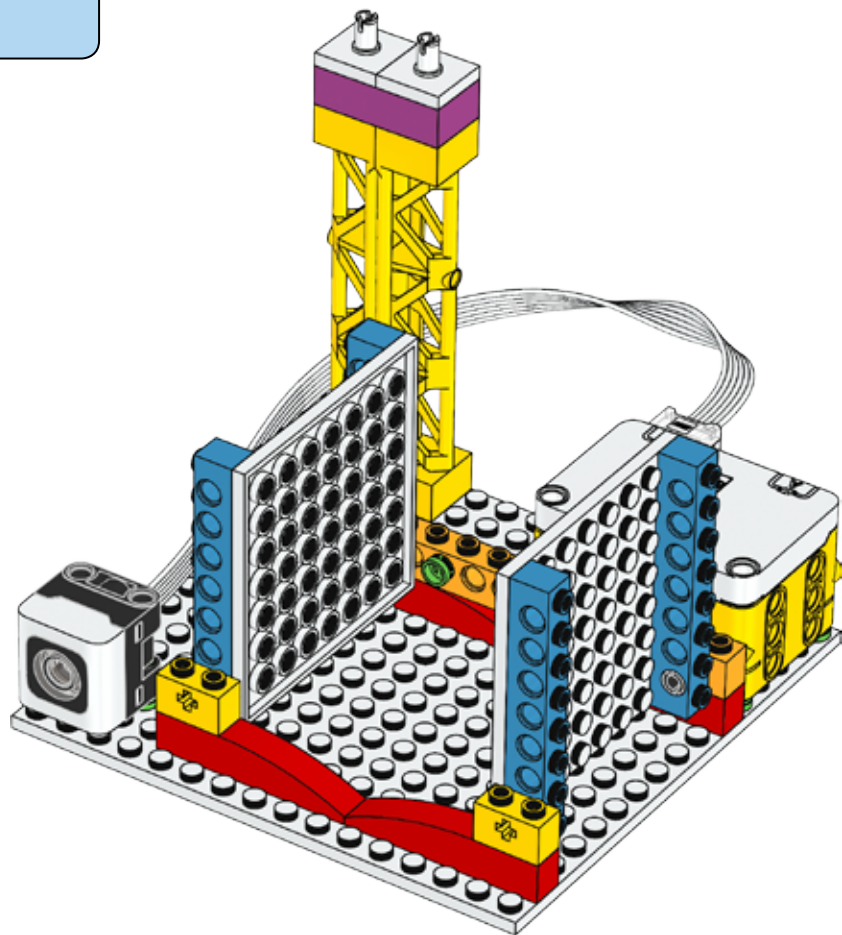



2x

18

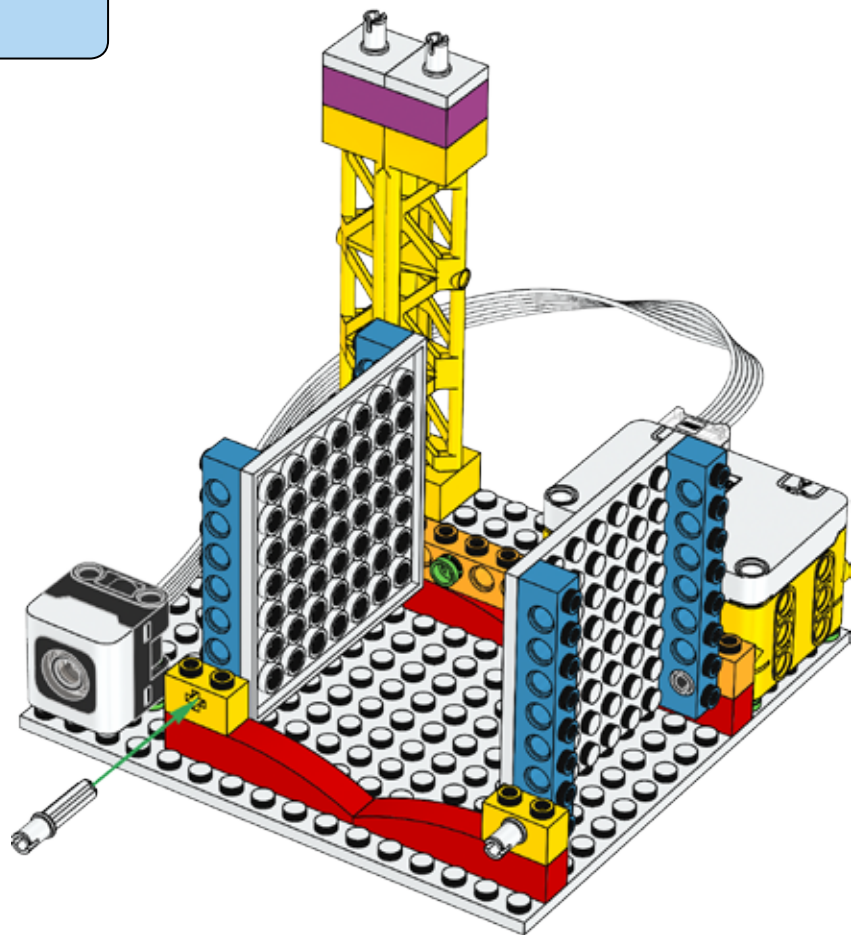

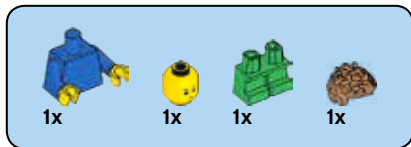

19

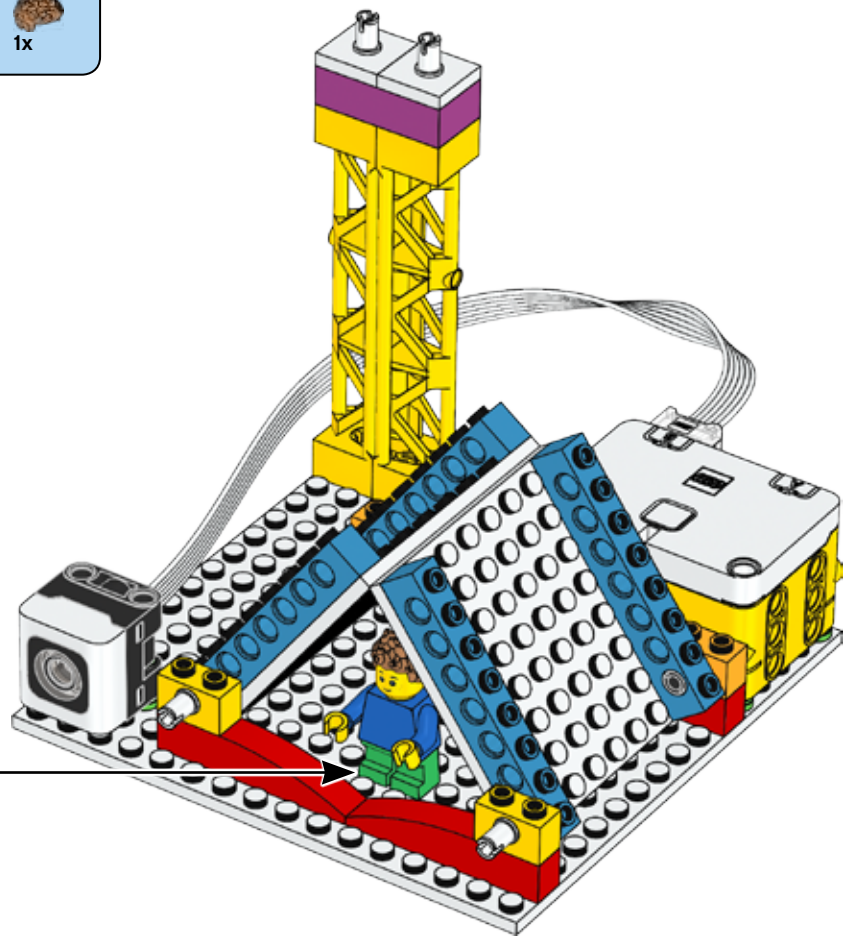

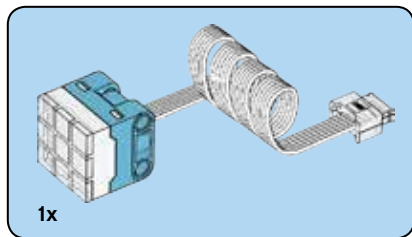

20

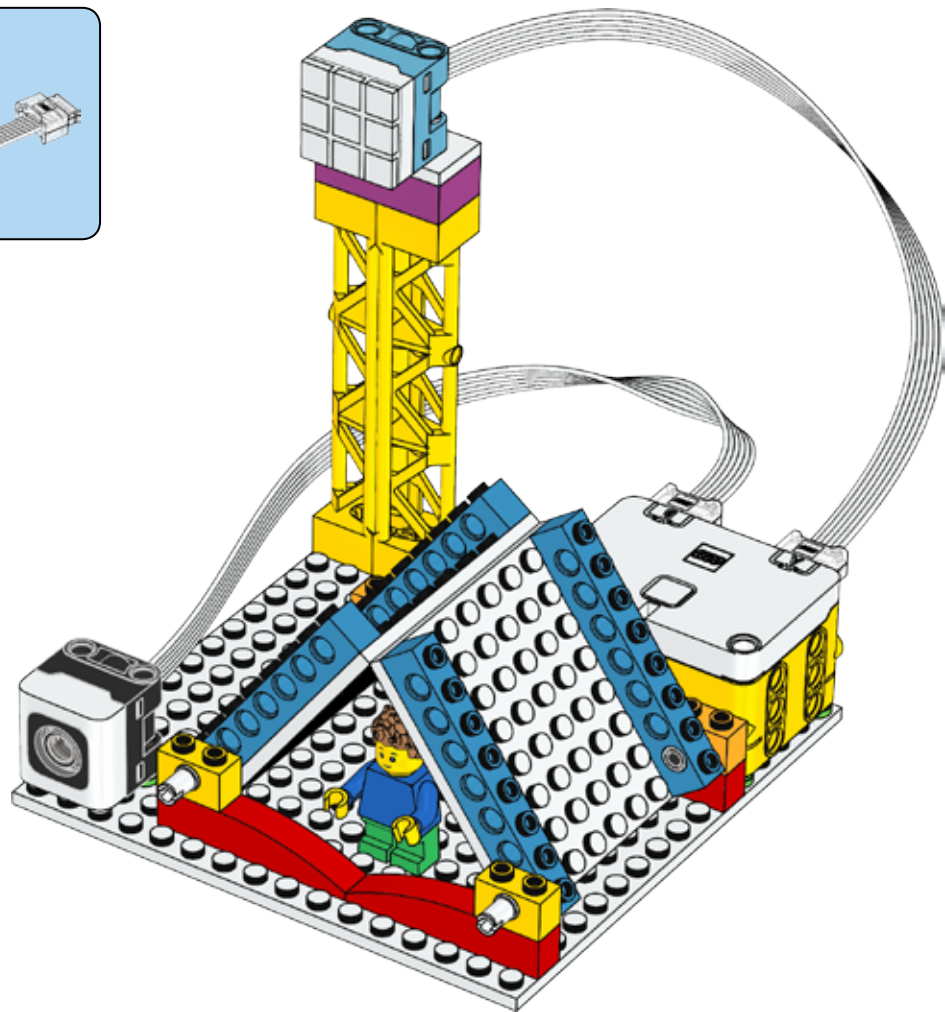



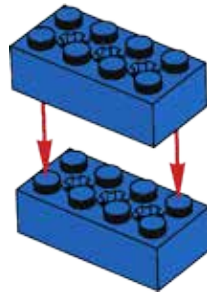

2x

21



1x  2x 

22

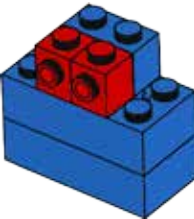





2x

23

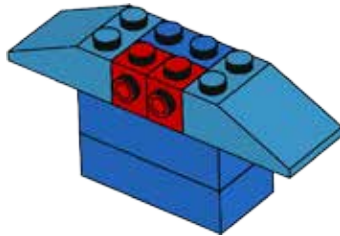



2x

24

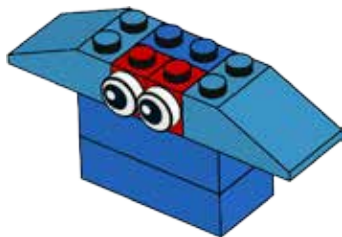



1x

25

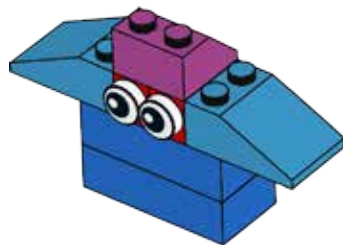



2x

26

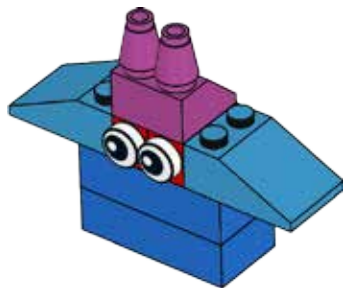



2x

27

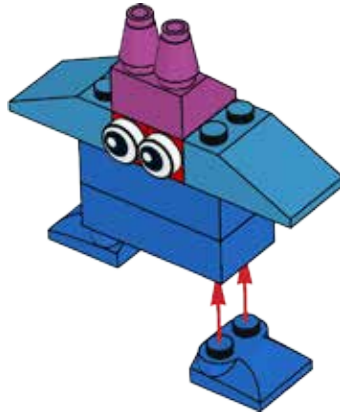

28

